

ACCESS FITTINGS

No other manufacturer offers such an extensive range of access fitting sizes (1/2" to 4") or hub configurations (LB, T, LL, LR, TB, C, E). CSA certified and UL listed, Scepter access fittings come fully factory assembled so parts cannot be misplaced during shipping and handling.

Manufactured with threaded brass screws and inserts, and flexible PVC gaskets, Scepter access covers can be removed as often as needed without wear or cracking. Stainless steel screws are available on request.

| Size inches | A inches | B inches | C inches | D inches | E inches | F inches |
|-------------|----------|----------|----------|----------|----------|----------|
|-------------|----------|----------|----------|----------|----------|----------|

Access Fitting Dimensions

| | | | | | | |
|-------|--------|-------|-------|-------|-------|--------|
| 1/2 | 5.606 | 0.639 | 1.268 | 1.100 | 0.840 | 4.337 |
| 3/4 | 5.606 | 0.810 | 1.536 | 1.325 | 1.050 | 5.395 |
| 1 | 6.500 | 0.910 | 1.700 | 1.660 | 1.335 | 6.250 |
| 1-1/4 | 7.900 | 1.050 | 2.300 | 2.250 | 1.100 | 7.625 |
| 1-1/2 | 8.500 | 1.125 | 2.675 | 2.250 | 1.900 | 8.250 |
| 2 | 10.875 | 1.160 | 3.188 | 2.820 | 2.375 | 10.531 |
| 2-1/2 | 14.600 | 1.750 | 4.500 | 3.950 | 2.870 | 13.630 |
| 3 | 14.600 | 1.900 | 4.500 | 3.950 | 3.510 | 13.630 |
| 3-1/2 | 17.040 | 2.125 | 5.536 | 5.000 | 4.000 | 16.000 |
| 4 | 17.040 | 2.125 | 5.536 | 5.000 | 4.530 | 16.000 |

| Size inches | G inches | H inches | I inches | J inches | K inches | L inches |
|-------------|----------|----------|----------|----------|----------|----------|
|-------------|----------|----------|----------|----------|----------|----------|

Access Fitting Dimensions

| | | | | | | |
|-------|--------|-------|-------|-------|-------|-------|
| 1/2 | 4.095 | 1.297 | 2.487 | 2.280 | 1.005 | 0.750 |
| 3/4 | 4.095 | 1.297 | 2.487 | 2.803 | 1.005 | 0.810 |
| 1 | 4.750 | 1.500 | 2.075 | 3.250 | 1.125 | 1.115 |
| 1-1/4 | 5.750 | 1.750 | 3.575 | 3.950 | 1.562 | 1.300 |
| 1-1/2 | 6.500 | 1.750 | 3.938 | 4.250 | 1.656 | 1.425 |
| 2 | 8.156 | 2.344 | 4.535 | 5.438 | 1.968 | 1.160 |
| 2-1/2 | 9.825 | 3.805 | 6.240 | 7.300 | 2.610 | - |
| 3 | 10.897 | 2.733 | 6.240 | 7.300 | 2.610 | - |
| 3-1/2 | 11.465 | 4.535 | 7.500 | 8.535 | 2.975 | - |
| 4 | 11.465 | 4.535 | 7.500 | 8.535 | 2.975 | - |

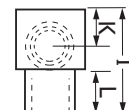
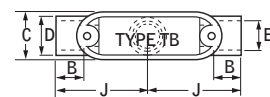
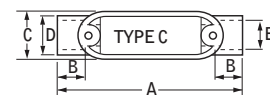
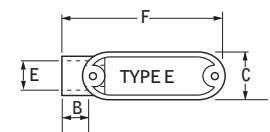
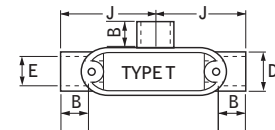
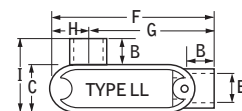
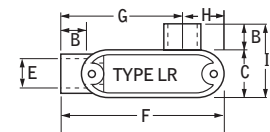
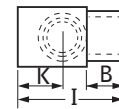
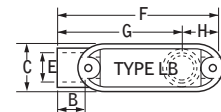



All access fittings are CSA certified and UL listed for wet locations, except Type TB. Supplied with threaded brass inserts, combination brass head screws and PVC gasketing. Stainless steel screws are available upon request.

ACCESS FITTINGS

| | Hub Size inches | Part Number | Product Code |
|---|--------------------|----------------|-----------------|
|  | 1/2 | SLB10S | 077541 |
| | 3/4 | SLB20S | 077542 |
| | 1 | SLB30S | 077543 |
| | 1-1/4 | SLB40S | 077544 |
| | 1-1/2 | SLB50S | 077545 |
| | 2 | SLB60S | 077546 |
| | 2-1/2 | SLB70S | 077547 |
| | 3 | SLB80S | 077548 |
| | 3-1/2 | SLB90S | 077549 |
| | 4 | SLB100S | 077550 |

| | Hub Size inches | Part Number | Product Code |
|---|--------------------|----------------|-----------------|
|  | 1/2 | SLL10S | 077521 |
| | 3/4 | SLL20S | 077522 |
| | 1 | SLL30S | 077523 |
| | 1-1/4 | SLL40S | 077524 |
| | 1-1/2 | SLL50S | 077525 |
| | 2 | SLL60S | 077526 |
| | 2-1/2 | SLL70S | 077527 |
| | 3 | SLL80S | 077528 |
| | 3-1/2 | SLL90S | 077530 |
| | 4 | SLL100S | 077529 |

| | Hub Size inches | Part Number | Product Code |
|---|--------------------|----------------|-----------------|
|  | 1/2 | ST10S | 077461 |
| | 3/4 | ST20S | 077462 |
| | 1 | ST30S | 077463 |
| | 1-1/4 | ST40S | 077464 |
| | 1-1/2 | ST50S | 077465 |
| | 2 | ST60S | 077466 |
| | 2-1/2 | ST70S | 077467 |
| | 3 | ST80S | 077468 |
| | 3-1/2 | ST90S | 077571 |
| | 4 | ST100S | 077572 |

| | Hub Size inches | Part Number | Product Code |
|---|--------------------|----------------|-----------------|
|  | 1/2 | SLR10S | 077481 |
| | 3/4 | SLR20S | 077482 |
| | 1 | SLR30S | 077483 |
| | 1-1/4 | SLR40S | 077484 |
| | 1-1/2 | SLR50S | 077485 |
| | 2 | SLR60S | 077486 |
| | 2-1/2 | SLR70S | 077480 |
| | 3 | SLR80S | 077488 |
| | 3-1/2 | SLR90S | 077487 |
| | 4 | SLR100S | 077489 |

| | Hub Size inches | Part Number | Product Code |
|--|--------------------|----------------|-----------------|
|  | 1/2 | SC10S | 077501 |
| | 3/4 | SC20S | 077502 |
| | 1 | SC30S | 077503 |
| | 1-1/4 | SC40S | 077504 |
| | 1-1/2 | SC50S | 077505 |
| | 2 | SC60S | 077506 |
| | 2-1/2 | SC70S | 077507 |
| | 3 | SC80S | 077508 |
| | 3-1/2 | SC90S | 077510 |
| | 4 | SC100S | 077509 |

| | Hub Size inches | Part Number | Product Code |
|--|--------------------|----------------|-----------------|
|  | 1/2 | SE10S | 077561 |
| | 3/4 | SE20S | 077562 |
| | 1 | SE30S | 077563 |
| | 1-1/4 | SE40S | 077564 |
| | 1-1/2 | SE50S | 077565 |
| | 2 | SE60S | 077566 |
| | 2-1/2 | SE70S | 077567 |
| | 3 | SE80S | 077568 |
| | 3-1/2 | SE90S | 077569 |
| | 4 | SE100S | 077570 |

| | Hub Size inches | Part Number | Product Code |
|--|--------------------|----------------|-----------------|
|  | 1/2 | STB10S | 077451 |
| | 3/4 | STB20S | 077452 |
| | 1 | STB30S | 077453 |
| | 1-1/4 | STB40S | 077454 |
| | 1-1/2 | STB50S | 077455 |
| | 2 | STB60S | 077456 |

“Two In One” Pull Elbow

The “two in one” access pull elbow reduces inventory costs (3/4" hub fitting supplied with 3/4" x 1/2" reducers). This pull elbow is approved for wet locations and provides for easy wire pulling.

“Two In One” Pull Elbow

| | Hub Size inches | Part Number | Product Code |
|--|--------------------|----------------|-----------------|
|  | 1/2 or 3/4 | PE15/10 | 077491 |

All access fittings are CSA certified and UL listed for wet locations, except Type TB. Supplied with threaded brass inserts, combination brass head screws and PVC gasketing. Stainless steel screws are available upon request.

SERVICE ENTRANCE FITTINGS

Scepter rigid PVC conduit is suitable for use in both overhead and underground service laterals. A complete range of non-corroding PVC service entrance fittings is available, including meter hubs, weather heads and meter offsets.

| Size inches | Part Number | Product Code |
|-------------|-------------|--------------|
|-------------|-------------|--------------|

Service Entrance Fittings



| | | |
|-------|------|--------|
| 1/2 | EF10 | 077281 |
| 3/4 | EF15 | 077282 |
| 1 | EF20 | 077283 |
| 1-1/4 | EF25 | 077284 |
| 1-1/2 | EF30 | 077285 |
| 2 | EF35 | 077286 |
| 2-1/2 | EF40 | 077287 |
| 3 | EF45 | 077288 |
| 3-1/2 | EF50 | 077289 |
| 4 | EF55 | 077290 |

| Size inches | Part Number | Product Code |
|-------------|-------------|--------------|
|-------------|-------------|--------------|

Scepter PVC Expansion Joints (c/w TA fitting)

| | | |
|-------|--------|--------|
| 2 | EJ35TA | 077680 |
| 2-1/2 | EJ40TA | 077398 |
| 3 | EJ45TA | 077681 |
| 4 | EJ55TA | 077682 |

These special Scepter PVC expansion joints are supplied with the appropriately sized TA fitting. Assembled at the factory, the fittings are ready for installation directly to the meter socket. The installer needs only to 'set' the piston opening when connecting the underground raceway.

| Size inches | Part Number | Product Code | A inches | B inches |
|-------------|-------------|--------------|----------|----------|
|-------------|-------------|--------------|----------|----------|

Long Meter Offsets Fabricated



| | | | | |
|-------|-------|--------|----|------|
| 1-1/4 | LM025 | 069641 | 12 | 0.92 |
| 1-1/2 | LM030 | 069645 | 12 | 1.69 |
| 2 | LM035 | 069646 | 14 | 1.52 |

| Size inches | Part Number | Product Code |
|-------------|-------------|--------------|
|-------------|-------------|--------------|

Scepter Slip Meter Risers (c/w TA fitting)

| | | |
|-------|---------|--------|
| 2 | SMR20TA | 068371 |
| 2-1/2 | SMR25TA | 068372 |
| 3 | SMR30TA | 068373 |
| 4 | SMR40TA | 068374 |

Slip Meter Risers allow the underground PVC service conduit to 'slip' inside the fitting and thus account for ground movement. The factory assembled SMR fitting is supplied with a male adapter, is 2 feet in length and is sized to accept the underground raceway (i.e. 2" underground service conduit requires a 2" SMR). The SMR fitting must be installed with the open barrel end towards the ground.

| Size inches | Part Number | Product Code |
|-------------|-------------|--------------|
|-------------|-------------|--------------|

Meter Offsets



| | | |
|-------|------|--------|
| 1-1/4 | M025 | 077941 |
| 2 | M035 | 077942 |

Meter Hubs

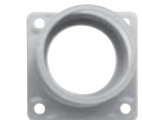

| | | |
|-------|-------|--------|
| 1-1/4 | MHU25 | 077961 |
| 1-1/2 | MHU30 | 077963 |
| 2 | MHU35 | 077965 |
| 2-1/2 | MHU40 | 077967 |
| 3 | MHU45 | 077968 |

BOXES - F SERIES

Our complete range of Scepter boxes and covers makes it easy to locate power and control precisely where you want it.

Scepter F-Series 3-in-1 PVC surface mount outlet boxes are available in single (deep), double and triple-gang configurations, with 1/2", 3/4" and 1" entry hubs all in one box. This innovative design enables contractors to reduce inventory, while ensuring they have the size they need when they need it.

With the exception of the FD, FD2 & FD3 Blank Boxes, Scepter F Series Boxes are molded with 1" conduit hubs and supplied with reducer bushings. The conduit hub(s) are field modified as 1/2", 3/4" or 1" to accommodate job-site requirements. The appropriate quantity of 1" x 3/4" and 3/4" x 1/2" reducers to create the desired hub size are packaged with each FD Series Single Gang Deep, Double Gang and Triple Gang Box.

All F Series boxes are supplied with integral mounting feet, threaded brass inserts and grounding screw.

| Hub Size inches | Part Number | Product Code | Volume in ³ |
|-----------------|-------------|--------------|------------------------|
|-----------------|-------------|--------------|------------------------|

Single Gang Boxes

| | | | |
|-----|--------|--------|------|
| 1/2 | FSC10 | 077607 | 17.0 |
| 3/4 | FSC15 | 077608 | 17.0 |
| 1/2 | FS10 | 077601 | 17.5 |
| 3/4 | FS15 | 077602 | 17.5 |
| 1/2 | FSCC10 | 077622 | 16.3 |
| 3/4 | FSCC15 | 077623 | 16.3 |
| 1/2 | FSS10 | 077604 | 17.0 |
| 3/4 | FSS15 | 077605 | 17.0 |

Note: 10 = 1/2" Hub, 15 = 3/4" Hub
Outside Dimensions: Length, 4-9/16" - Width, 2-13/16" - Depth, 2"



FSC



FS



FSCC



FSS

Single Gang Deep Boxes

| | | | |
|-------------|-----------|--------|------|
| 1/2, 3/4, 1 | FDC101520 | 077291 | 26.0 |
| 1/2, 3/4, 1 | FDS101520 | 077299 | 26.8 |
| BLANK | FD BLANK | 077603 | 29.2 |
| 347 VOLT | FD347 | 077610 | 29.2 |

Note: 10 = 1/2" Hub, 15 = 3/4" Hub, 20 = 1" Hub
Outside Dimensions: Height, 4 9/16" - Width, 2 13/16" - Depth 2 3/4",
Cubic Inches = 35.30



FDC101520



FDS101520



FD Blank

BOXES - F SERIES



Universal Double Gang boxes – NEW Style

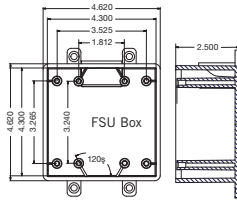

| Hub Size inches | Part Number | Product Code |
|-----------------|-------------|--------------|
|-----------------|-------------|--------------|

| | | |
|-------------|----------------|--------|
| 1/2, 3/4, 1 | FSU-2-101520 | 077364 |
| 1/2, 3/4, 1 | FSCU-2-101520 | 077368 |
| 1/2, 3/4, 1 | FSSU-2-101520 | 077372 |
| 1/2, 3/4, 1 | FSCCU-2-101520 | 077369 |
| Blank | FDU-2 | 077649 |

Note: FS-2 cu.in = 39.5, FSC-2 & FSS-2 cu.in. = 37.0, FSCC-2 cu.in. = 36.0

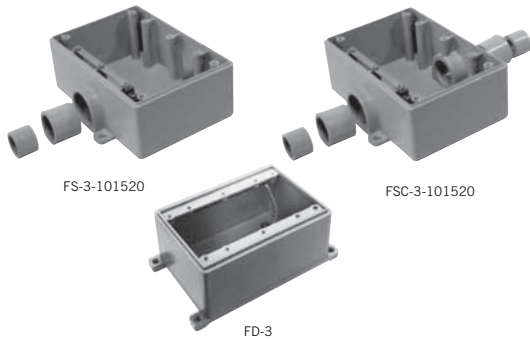
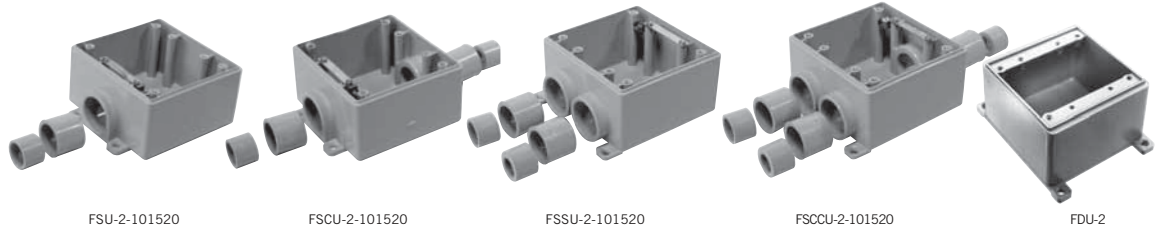

Triple Gang Boxes

| | | |
|-------------|--------------|--------|
| 1/2, 3/4, 1 | FS-3-101520 | 077337 |
| 1/2, 3/4, 1 | FSC-3-101520 | 077438 |
| Blank | FD-3 | 077737 |

Octagonal Boxes are shipped complete with cover, gasket, 4 reducing bushings (3/4" x 1/2"), and 4 sealing caps to be installed from inside box to seal off unused entry hubs.

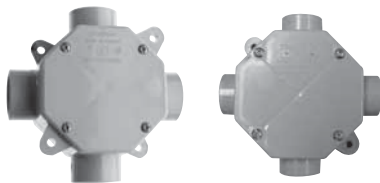

| Size inches | Part Number | Hub Size inches | Product Code |
|-------------|-------------|-----------------|--------------|
|-------------|-------------|-----------------|--------------|

Octagonal Boxes

| | | | |
|-----------|---------|-----------|--------|
| 4 x 1-1/2 | OB15/10 | 1/2 - 3/4 | 077983 |
| 4 x 2-1/8 | OB20 | 1 | 077984 |

Note: Octagonal Boxes are not designed for supporting light fixtures.

| Size inches | Part Number | Product Code |
|-------------|-------------|--------------|
|-------------|-------------|--------------|

Octagonal Box Extension Rings

| | | |
|------------|------|--------|
| 4 x 1 deep | XR20 | 077989 |
| 4 x 2 deep | XR35 | 077990 |



COVER PLATES - F SERIES

| Description | Part Number | Product Code |
|-------------|-------------|--------------|
|-------------|-------------|--------------|

Single Gang Plates

| | | |
|-------------------|-------------|--------|
| Duplex Receptacle | DRC15/10 | 077617 |
| Toggle Switch | TSC15/10 | 077616 |
| Single Receptacle | 20RC15/10 | 077618 |
| Single Receptacle | 20-3RC15/10 | 077619 |
| Single Receptacle | 30-3RC15/10 | 077620 |
| Blank c/w Gasket | BRC15/10 | 077611 |
| PVC Gasket | GASK15/10 | 077621 |



Double Gang Plates – OLD Style

| | | |
|--------------------------------|----------|--------|
| Blank Cover c/w Gasket | BRC20-2 | 077614 |
| Double Switch | TSC20-2 | 077738 |
| Double Duplex Receptacle | DRC20-2 | 077740 |
| Combo Switch Duplex Receptacle | TSDC20-2 | 077739 |
| PVC Gasket | GASK20-2 | 077743 |

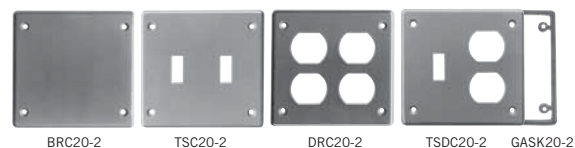

Universal Double Gang Plates – NEW Style *(only fits new style double gang boxes)*

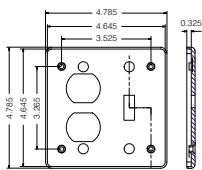

| | | |
|--------------------------------|------------|--------|
| Blank Cover c/w Gasket | BRCU20-2 | 077359 |
| Double Switch | TSCU20-2 | 077373 |
| Double Duplex Receptacle | DRCU20-2 | 077362 |
| Combo Switch Duplex Receptacle | TSDCU20-2 | 077374 |
| PVC Gasket | GASKFU20-2 | 172650 |

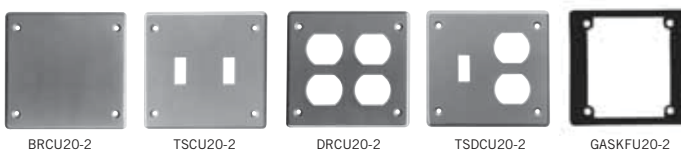

Triple Gang Plates

| | | |
|-------------------------|----------|--------|
| Triple Receptacle | DRC20-3 | 077747 |
| Combo Switch Receptacle | DSDR20-3 | 077745 |
| Triple Switch | TSC20-3 | 077744 |
| Combo Switch Receptacle | TSDC20-3 | 077746 |
| Blank Cover c/w Gasket | BRC20-3 | 077748 |
| PVC Gasket | GASK20-3 | 077749 |

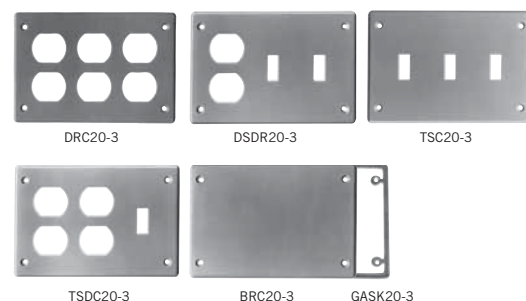

WEATHERPROOF COVERS

Manufactured with stainless steel return-springs/clips and packaged with brass screws, Scepter weatherproof covers provide a positive seal, even in cold temperatures.

| Description | Device Opening (in) | Part Number | Product Code |
|---|---------------------|-------------|--------------|
| Single Gang Weatherproof Covers | | | |
| Plunger-style Switch Cover | | VPT15/10 | 077630 |
| Toggle Switch Cover | | VSC15/10 | 077612 |
| Grey Toggle Switch Cover | | WTG15/10 | 077606 |
| Grey Duplex Receptacle | | WDR15/10 | 077993 |
| White Duplex Receptacle | | RWDR15/10 | 077786 |
| Grey Ground Fault Receptacle | | WGF15/10 | 077785 |
| White Ground Fault Receptacle | | RWGF15/10 | 077787 |
| Single Receptacle Device 15 AMP | 1.375 | WTL15 | 077992 |
| Single Receptacle Device 20 AMP | 1.625 | WTL20 | 077994 |
| Single Receptacle Device 30 AMP | 1.722 | WTL30 | 077991 |
| Single Receptacle Device 50 AMP | 2.187 | WTL50 | 077951 |
| Grey Double Door Duplex Receptacle | | WDRE15/10 | 077087 |
| White Double Door Duplex Receptacle | | RWDRE15/10 | 077408 |
| Gasket for W Series Cover (except WDRE & RWDRE) | | GASKW | 077755 |
| Gasket for WDRE & RWDRE Covers | | GASKDD | 072225 |

Gaskets are included with all weatherproof covers.



Double Gang Weatherproof Covers – OLD Style

| | | |
|---|-----------|--------|
| Toggle Switch Cover | VSC20-2 | 077741 |
| Combination Switch Cover & GFI Receptacle | VSRC20-2 | 077742 |
| Combination Switch Cover & Duplex Receptacle | VSDR20-2 | 077752 |
| Combination Switch Cover & Single Receptacle | VSRR20-2 | 077753 |
| Double Door GFCI Cover | VSGG20-2 | 077096 |
| Double Door Duplex Cover | VSDD20-2 | 077097 |
| Gasket for Double Gang (except VSGG20-2 & VSDD20-2) | GASK20-2 | 077743 |
| Gasket for VSGG20-2 and VSDD20-2 Double Gangs | GASKV20-2 | 072227 |

Gaskets are included with all weatherproof covers.

VSGG20-2 and VSDD20-2 are universal and will fit on most PVC and metal boxes.



Double Gang Weatherproof Covers – NEW Style *(only fits new style double gang boxes)*

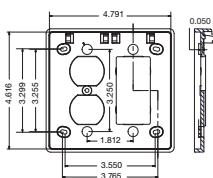

| | | |
|--|------------|--------|
| Toggle Switch Cover | VSCU20-2 | 077376 |
| Combination Switch Cover & GFI Receptacle | VSRCU20-2 | 077357 |
| Combination Switch Cover & Duplex Receptacle | VSDRU20-2 | 077356 |
| Gasket | GASKFU20-2 | 172650 |

