

VVP 24 1p-N



Specifications

ETI Code	004259010
Description	VVP 24 1p-N
Weight	4.3
Level	Fuse bases
Connection	M12X20
Product group	MV-fuse base
Rated AC voltage (V)	24000
Rated current (A)	200
Type	VVP-N

[Online product page](#) 

Other documentation



[Technical data catalogue](#)



ETIM international clasification

Number of poles	1
For fuse size	Other

Dimension drawing

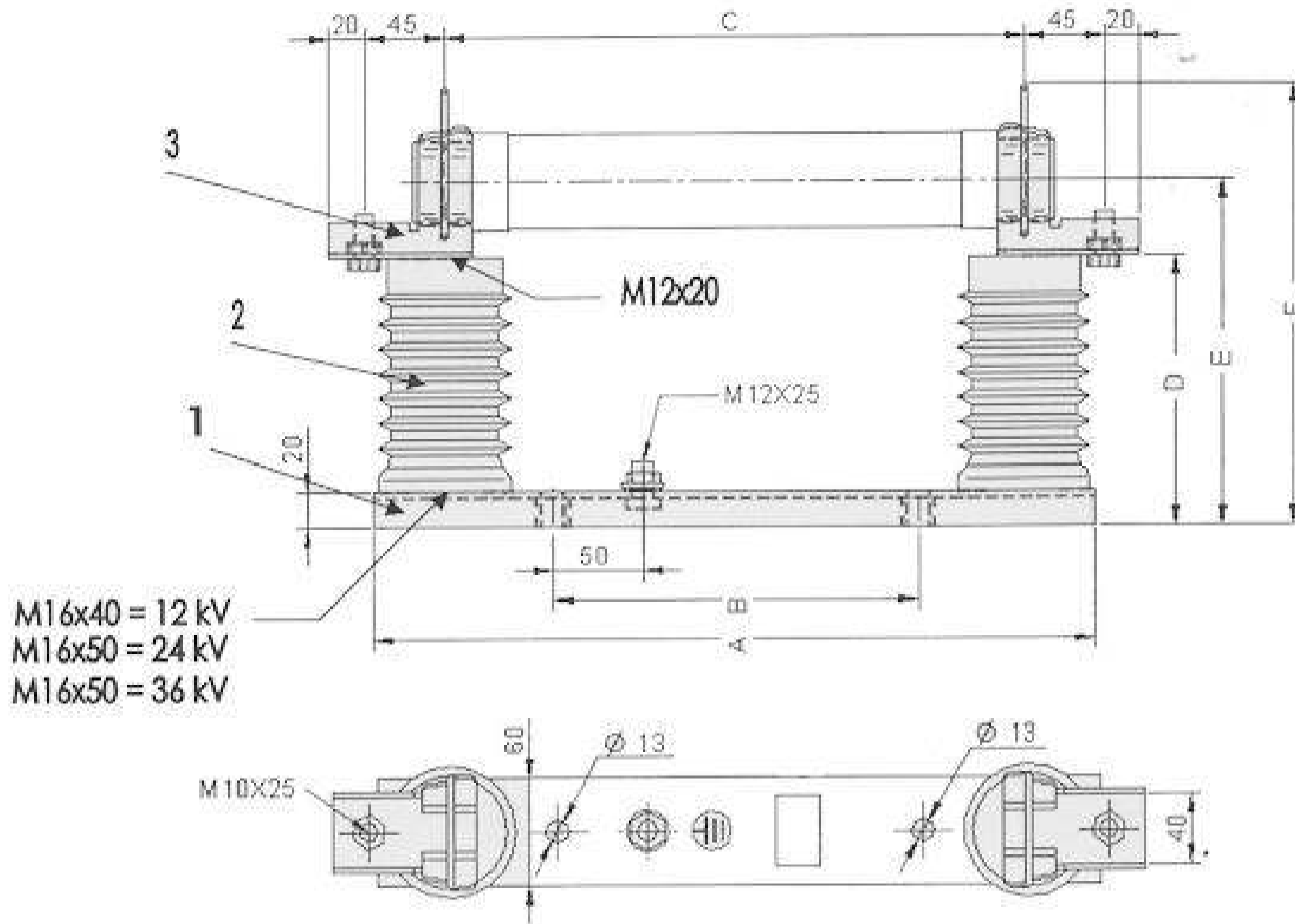

1-pole fuse-base	Rated voltage [kV]	A [mm]	B [mm]	C [mm]	D [mm]	E [mm]	F [mm]
INDOOR MOUNTING	7,2 & 12	405	205	325	152	195	250
	17,5 & 24	555	335	475	252	295	350
	36	650	450	570	332	375	430